



Scale: Legal Size

**EDIPHIQUE  
DEVELOPMENTS**

**Project Address:**  
239 Kathleen Street,  
Guelph ON

**Date:**  
July 5, 2023

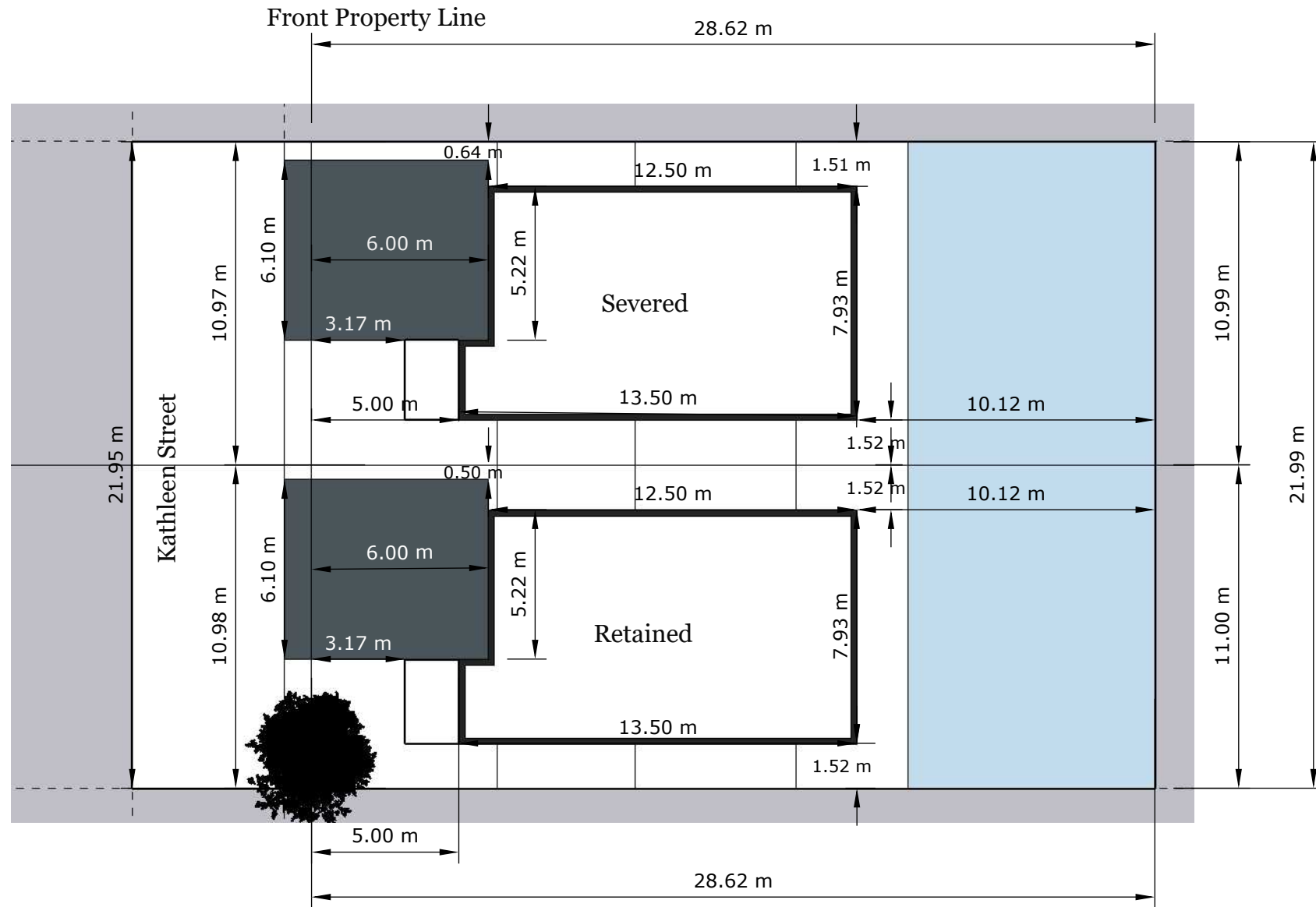

**A** :: Site Plan  
001 1mm: 200mm

Scale: Legal Size

<b>EDIPHIQUE DEVELOPMENTS</b>	<b>Project Address:</b> 239 Kathleen Street, Guelph ON	<b>Date:</b> July 5, 2023
-------------------------------	--	------------------------------

Kathleen Street

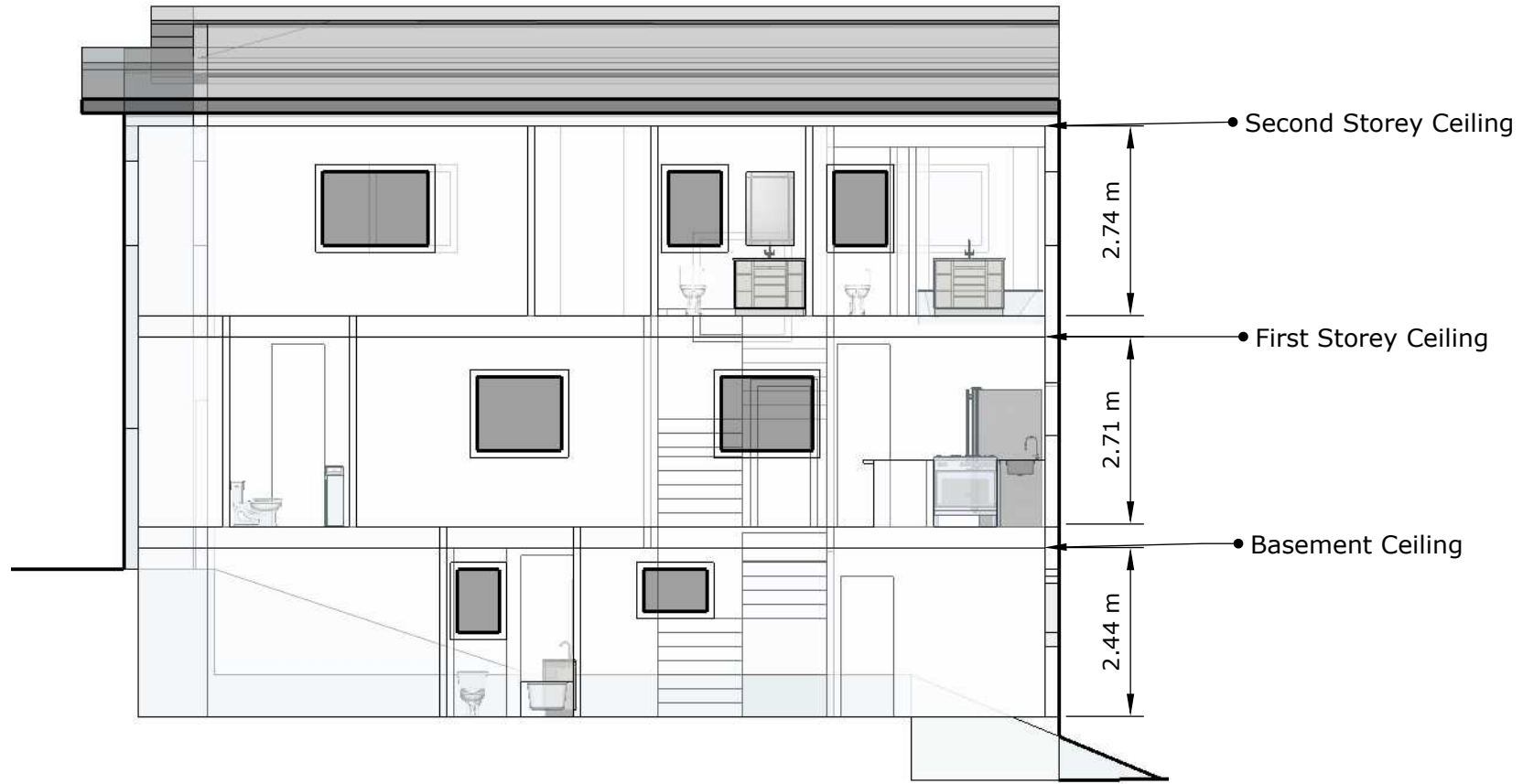

**A** :: Interior Elevations  
002 1mm:100mm

Scale: Legal Size

<b>EDIPHIQUE DEVELOPMENTS</b>	<b>Project Address:</b> 239 Kathleen Street, Guelph ON	<b>Date:</b> July 5, 2023
-------------------------------	--	------------------------------

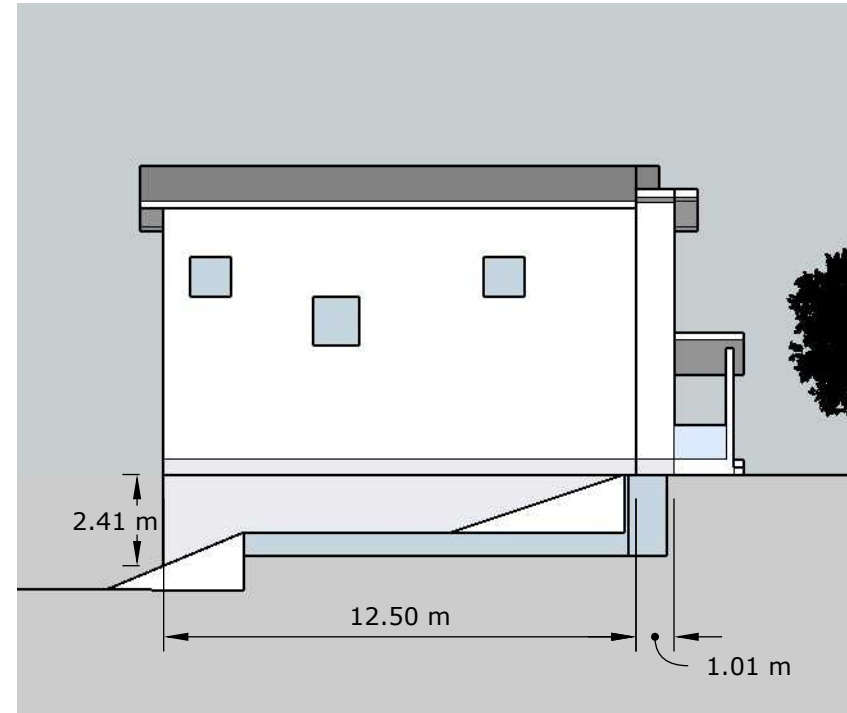
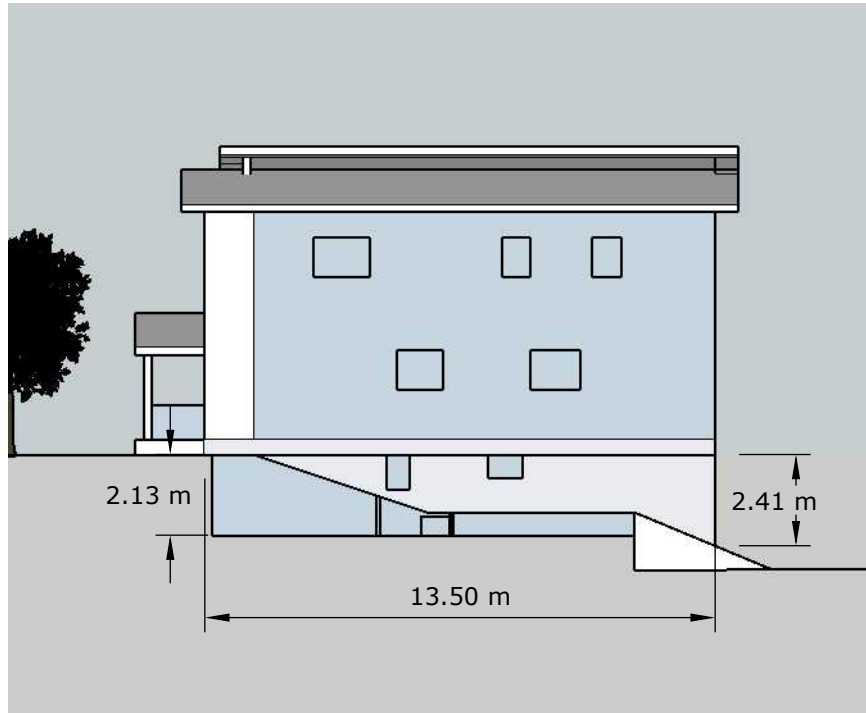

**A** :: Right and Left Side View  
 003 1mm:200mm

Scale: Legal Size

<b>EDIPHIQUE DEVELOPMENTS</b>	<b>Project Address:</b> 239 Kathleen Street, Guelph ON	<b>Date:</b> July 5, 2023
-----------------------------------	--	------------------------------

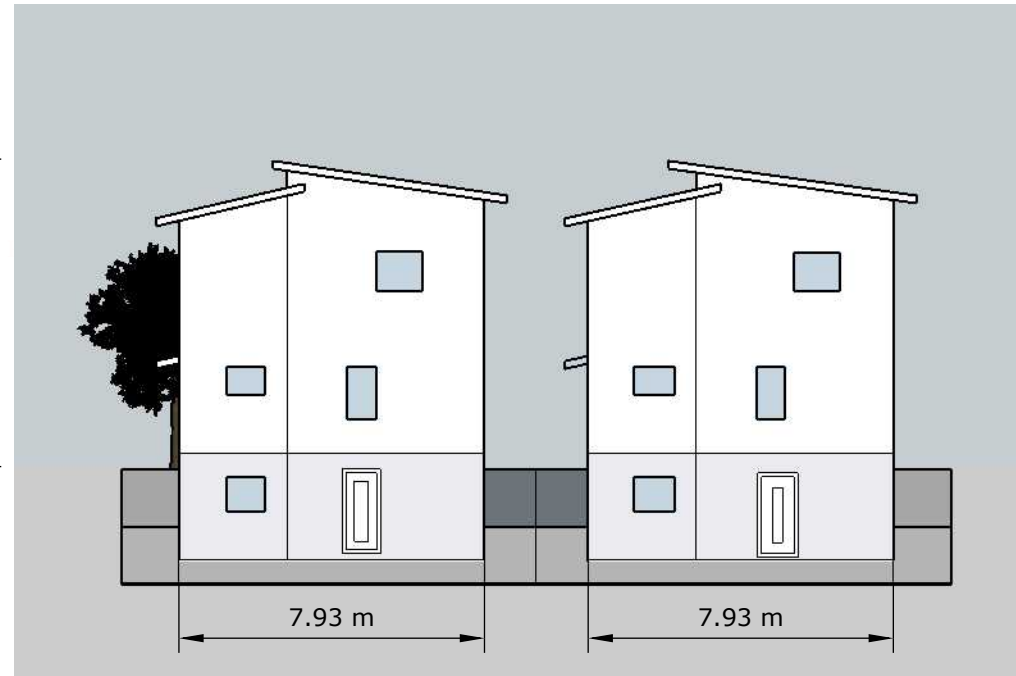
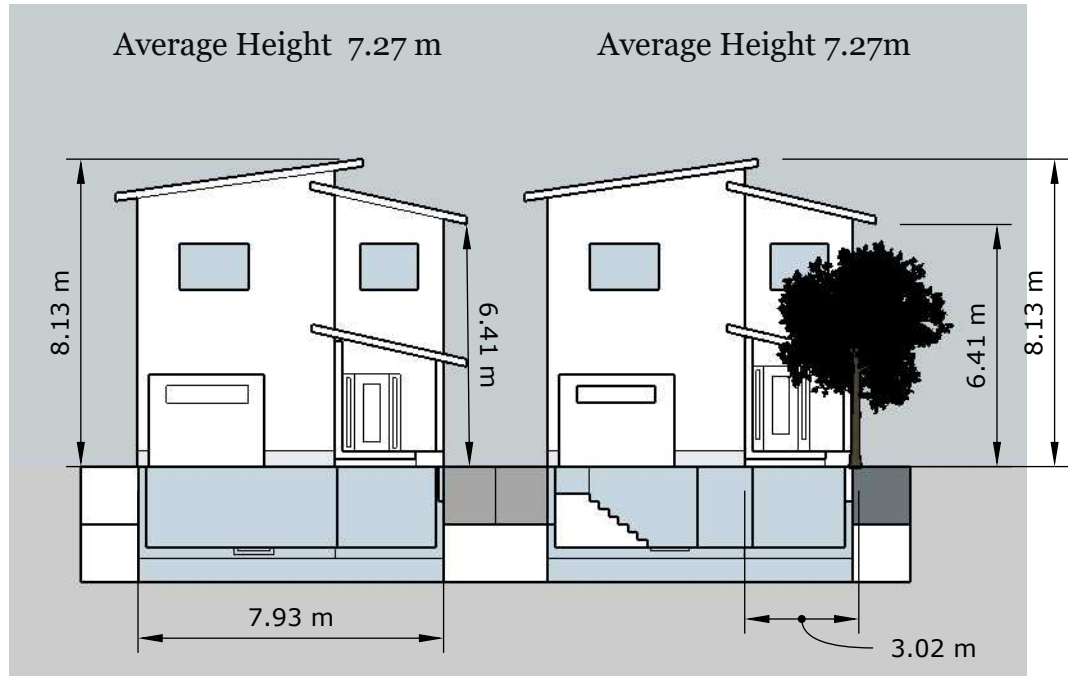

↙ Driveway Distance from City Tree

<b>A</b>	:: Front and Rear of Building
004	1mm: 200mm

Scale: Legal Size

<b>Date:</b> July 5, 2023
<b>Project Address:</b> 239 Kathleen Street, Guelph ON
<b>EDIPHIQUE DEVELOPMENTS</b>

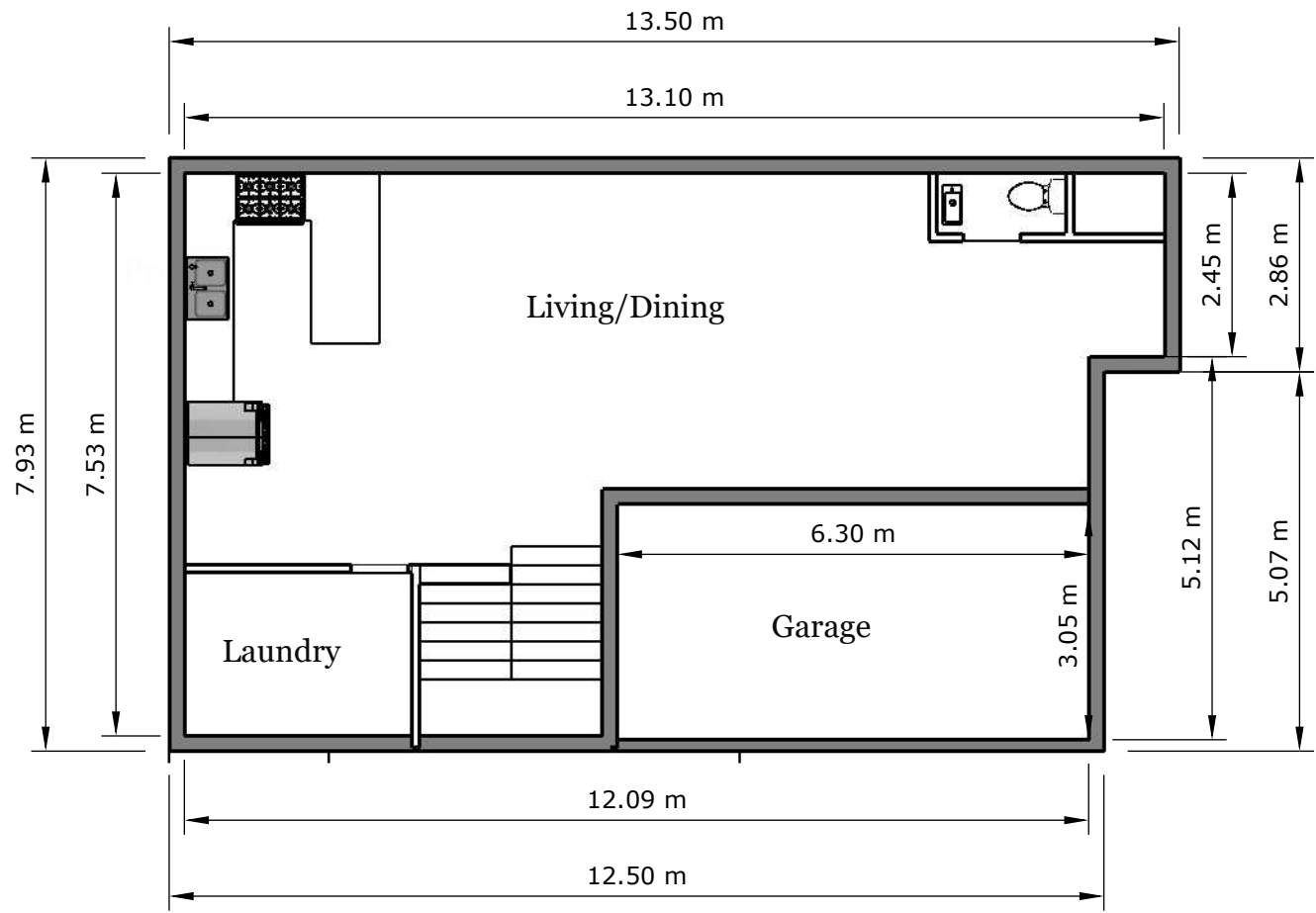

**A** :: First Storey Floor Plan  
 005 1mm: 100mm

Scale: Legal Size

<b>EDIPHIQUE DEVELOPMENTS</b>	<b>Project Address:</b> 239 Kathleen Street, Guelph ON	<b>Date:</b> July 5, 2023
-------------------------------	--	------------------------------

<b>A</b>	:: Second Storey Floor Plan
006	1mm:100mm

Scale: Legal Size

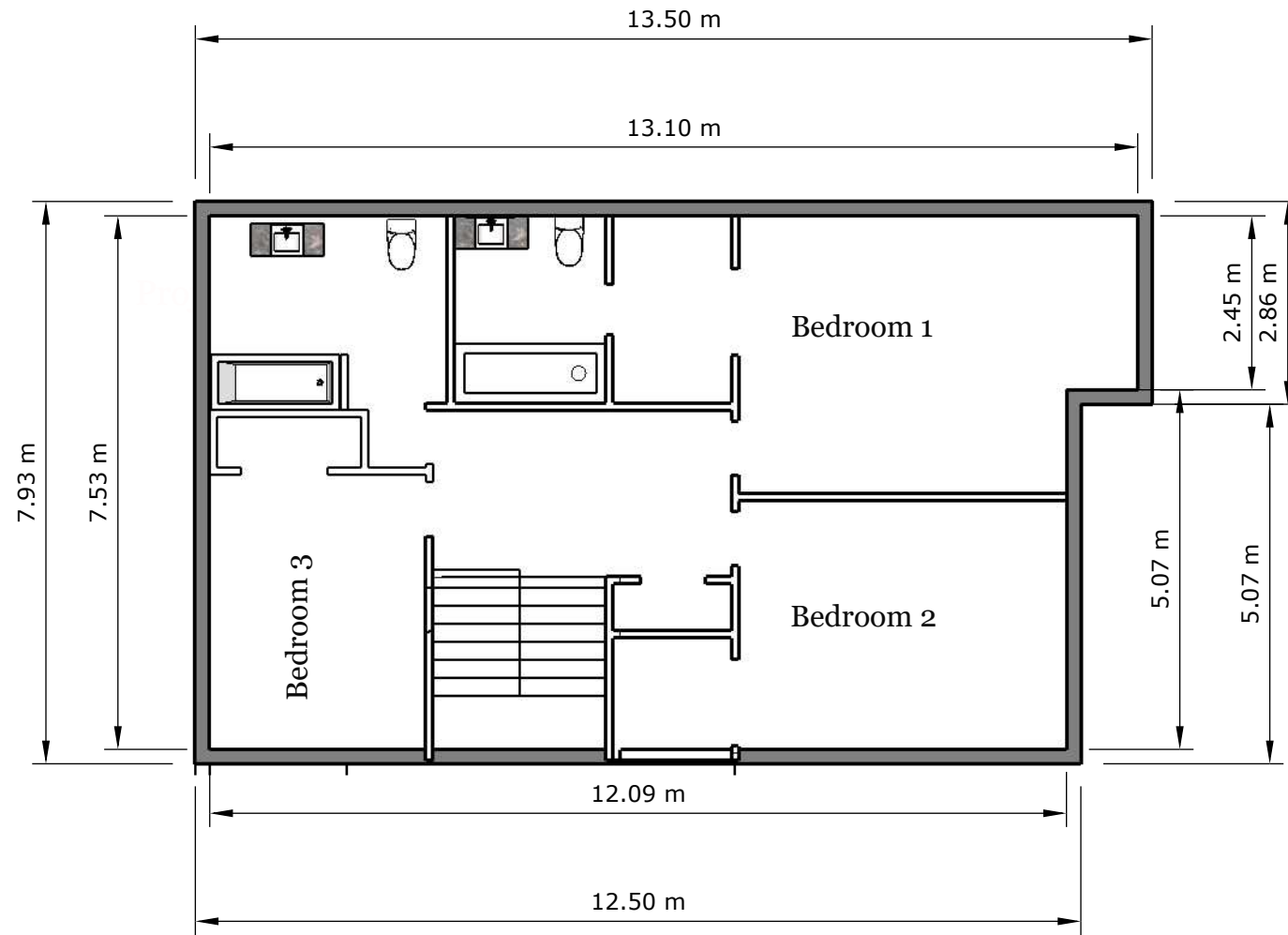

**EDIPHIQUE  
DEVELOPMENTS**

**Project Address:**  
239 Kathleen Street,  
Guelph ON

**Date:**  
July 5, 2023

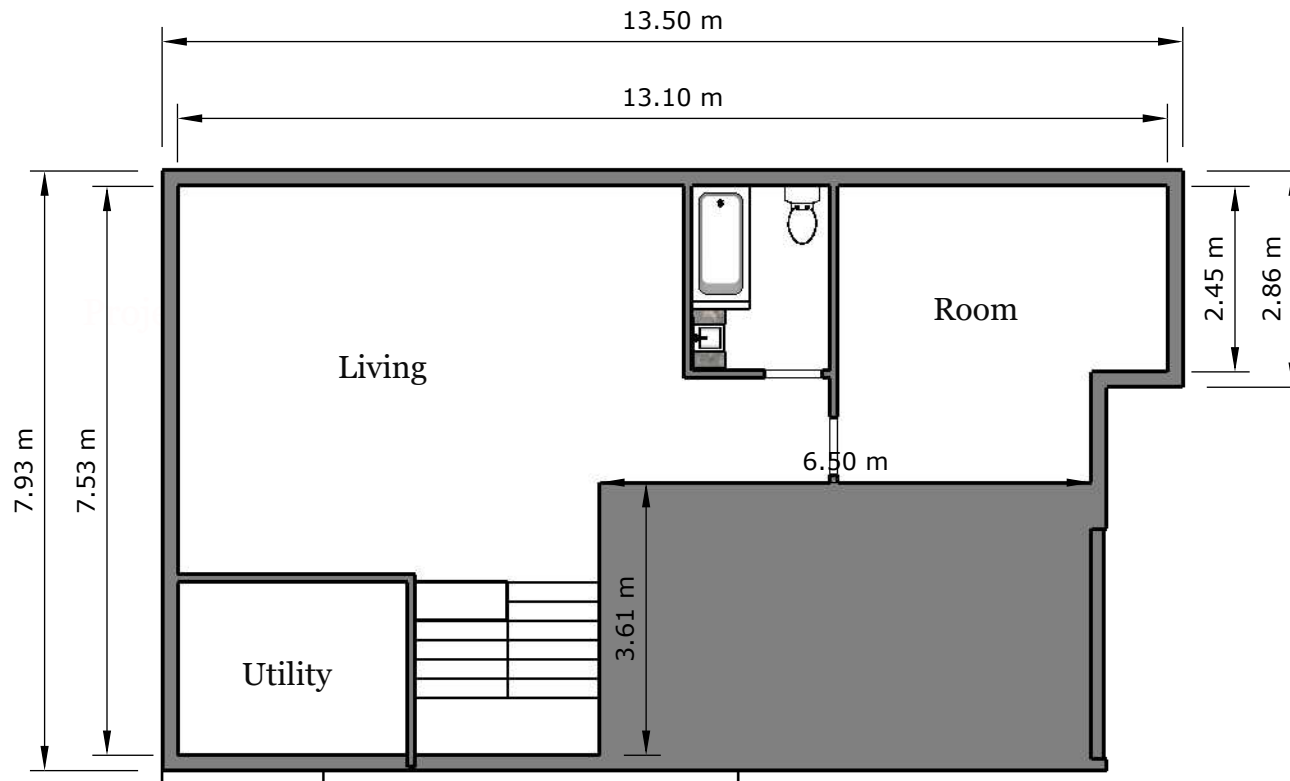

**A** :: **Basement Floor Plan**  
 007 1mm: 100mm

Scale: Legal Size

**EDIPHIQUE  
 DEVELOPMENTS**

**Project Address:**  
 239 Kathleen Street,  
 Guelph ON

**Date:**  
 July 5, 2023